

CSC, EFSCO, EFDC, EMHA

Command and control stations 'Ex d'

- Group IIC
- Zone 1, 2, 21, 22
- Aluminium alloy, stainless steel or cast iron enclosures
- Category 2GD or M2

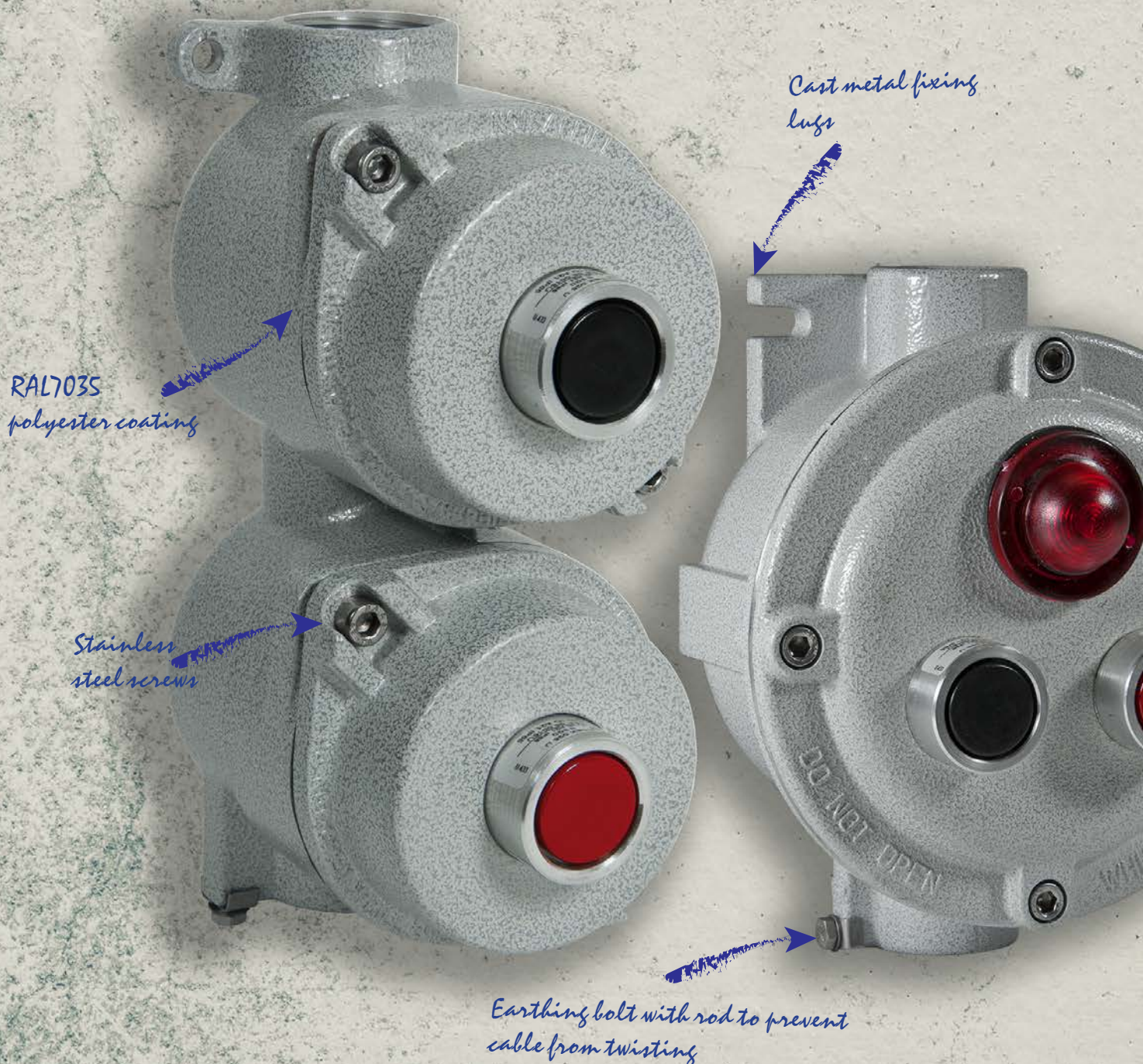

CSC Series... Control and signalling station

The Ex d IIC stations and controllers are suitable for the control and signalling of devices installed both "onboard" the machine and remotely (e.g. on a field control column). They are easily installed using wall mount lugs and have threaded entries for connection by means of a cable gland or metal pipe.

Used specifically in offshore and onshore environments, the chemical, petrochemical and pharmaceutical industries, and all locations which require an explosion proof system.

The switches, circuit breakers and selectors which make up the CSC series are 16 A rotary type with a front control handle. Supplied with 1" Male to 3/4" Female reducer. They are recommended for controlling devices both on board machine and on wall mounted columns. The various available cable arrangements make devices in the CSC series versatile for any type of use.

Cortem Group labels its products with a non-removable adhesive label featuring a hologram and an alphanumeric univocal code, as a safety measure against the illegal sale of fakes so that all the products are guaranteed as original. Non-compliance with the International standards entails serious risks for the environment, especially for those working daily on the plants.



Sectors of application:



Petroleum refineries



Chemical and petrochemical plants



Onshore plants



Offshore plants



Petroleum loading/unloading pontoons



Low temperatures



Mining operations



100% produced by Cortem

CERTIFICATION DATA

Classification:

Group II

Category 2GD/M2

Installation: EN 60079.14

zone 1 - zone 2 (Gas)

zone 21 - zone 22 (Dust)

Marking:

CE 0722 Ex I M2 Ex db I Mb (stainless steel and cast iron ONLY)

CE 0722 Ex II 2 GD; Ex db IIC T...°C Gb; Ex tb IIIC T...°C Db

Certificate:

ATEX CESI 01 ATEX 092 X

IEC Ex CES 17.0001X

TR CU AVAILABLE

For all IEC Ex and TR CU certification data, download the certificate from www.cortemgroup.com

Standards:

CENELEC EN 60079-0: 2012, EN 60079-0/A11: 2013, EN 60079-1: 2014 EN60079-31 2014 and European Directive 2014/34/EU
IEC 60079-0: 2011, IEC 60079-1: 2014, IEC 60079-31: 2013
RoHS Directive 2002/95/EC.

Temperature class:

T6 (Ta +40°C)

T5 (Ta +55°C)

Ambient Temp.:

-20°C +55°C

Standard

-50°C +55°C

Only for group II. The Group II monitoring and signalling units, equipped with polycarbonate signalling lenses, are limited to -40°C

Degree of protection:

IP66

CSC Series... Control and signalling station



CROSS-SECTION VIEW



MECHANICAL FEATURES OF ENCLOSURES

Body and lid:	Low copper content aluminium alloy, complete with wall fastening lugs.
Gaskets:	Acid, hydrocarbon and high temperature resistant silicon positioned between the body and the cover
Instrument casing:	Borosilicate glass
Certification label:	Adhesive affixed to external surface
Screws:	Stainless steel
Earth screw:	Internal M5 on body and lid connected by a 2.5 mm ² wire
Coating:	Polyester RAL 7035 (Light grey)
Threaded entries:	One upper and one lower Ø 1" complete with Male 1" - Female 3/4" adapter
Resistenza alla corrosione:	The STANDARD of the aluminium alloy used by Cortem has passed the tests required by standards EN60068-2-30 (hot-humid cycles) and EN60068-2-11 (salt fog test)

MECHANICAL FEATURES OF CONTROL AND SIGNALLING DEVICES

Pushbutton:	Coloured nylon
Illuminated pushbutton:	Clear coloured polycarbonate
Control levers:	Coated aluminium alloy
Badge:	Anodised aluminium, white lettering on black background
Internal bushing and pin:	Stainless steel
Gaskets:	Acid and hydrocarbon resistant NBR
Coating:	Polyester RAL 7035 (Light grey), where applicable
Station assembly:	Screwed onto cover
Contacts assembly:	Snap action on an appropriate flange to ensure the quick connection of entire contacts block to the station
External body lens:	Impact and UV resistant polycarbonate lens, coloured or transparent

ELECTRICAL FEATURES

Contacts for pushbuttons:	Max. 10A 600 V
Switches:	16A, 690 V
Indicator lights:	24/250V, 3W
Analogue instruments:	600V

ACCESSORIES UPON REQUEST / SPECIAL REQUESTS

RAL 2004 (Pure orange) internal anti-condensation coating
External polyester coatings in various colours (specify RAL colour)
Stainless steel or cast iron version available with minimum production batches. Contact your sales representative for more details.
(sample code stainless steel CSC-DIN, cast iron sample code CSC-DGJ)
Cablegland / fittings
System protecting against accidental operation for mushroom-head push-buttons serie CSC-R (code M-990)

CSC Series... Control and signalling station

DIMENSIONAL DRAWING

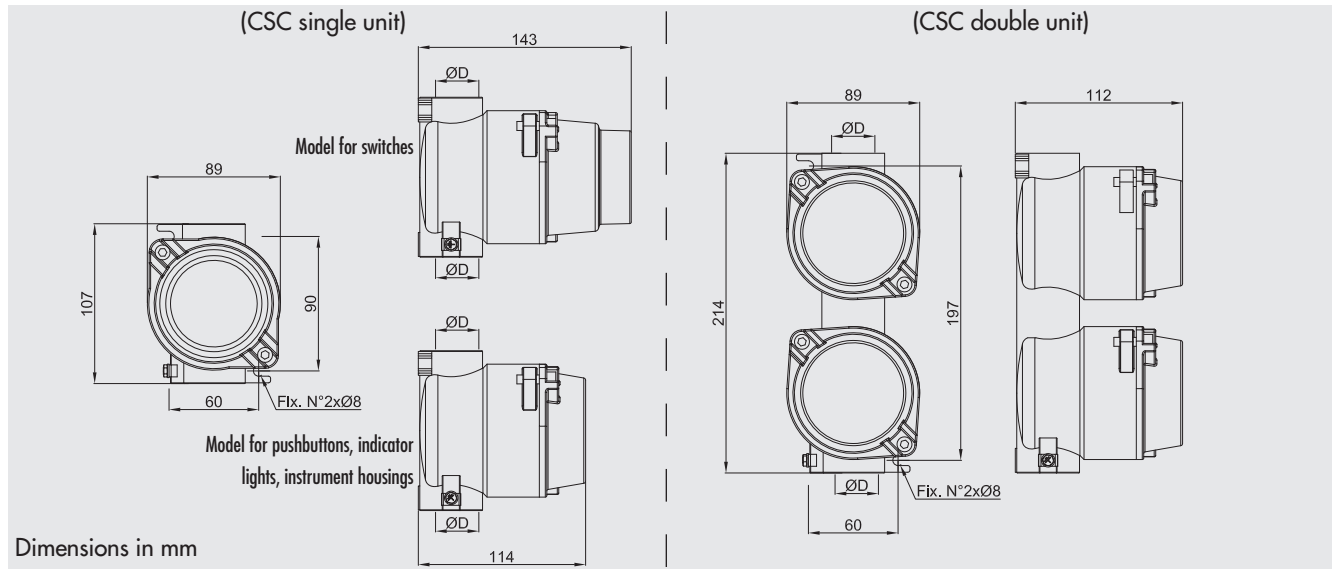















SELECTOR ARRANGEMENT

Description	Badge	Single pole arrangement	Contacts	Single pole arrangement	Contacts	Codes																				
Motors "start-stop" control, with spring return to 0 from both STOP and START.			<table border="1"> <thead> <tr> <th>POS.</th> <th>CONTACT</th> </tr> <tr> <td></td> <td>1-2 3-4</td> </tr> </thead> <tbody> <tr> <td>STOP</td> <td>0 0</td> </tr> <tr> <td>0</td> <td>X 0</td> </tr> <tr> <td>START</td> <td>X X</td> </tr> </tbody> </table>	POS.	CONTACT		1-2 3-4	STOP	0 0	0	X 0	START	X X		<table border="1"> <thead> <tr> <th>POS.</th> <th>CONTACT</th> </tr> <tr> <td></td> <td>1-2 3-4 5-6 7-8</td> </tr> </thead> <tbody> <tr> <td>STOP</td> <td>0 0 0 0</td> </tr> <tr> <td>0</td> <td>X 0 X 0</td> </tr> <tr> <td>START</td> <td>X X X X</td> </tr> </tbody> </table>	POS.	CONTACT		1-2 3-4 5-6 7-8	STOP	0 0 0 0	0	X 0 X 0	START	X X X X	X
POS.	CONTACT																									
	1-2 3-4																									
STOP	0 0																									
0	X 0																									
START	X X																									
POS.	CONTACT																									
	1-2 3-4 5-6 7-8																									
STOP	0 0 0 0																									
0	X 0 X 0																									
START	X X X X																									
Motors "start-stop" control with spring return from START to 0, and in fixed STOP position can be padlocked.			<table border="1"> <thead> <tr> <th>POS.</th> <th>CONTACT</th> </tr> <tr> <td></td> <td>1-2 3-4</td> </tr> </thead> <tbody> <tr> <td>STOP</td> <td>0 0</td> </tr> <tr> <td>0</td> <td>X 0</td> </tr> <tr> <td>START</td> <td>X X</td> </tr> </tbody> </table>	POS.	CONTACT		1-2 3-4	STOP	0 0	0	X 0	START	X X		<table border="1"> <thead> <tr> <th>POS.</th> <th>CONTACT</th> </tr> <tr> <td></td> <td>1-2 3-4 5-6 7-8</td> </tr> </thead> <tbody> <tr> <td>STOP</td> <td>0 0 0 0</td> </tr> <tr> <td>0</td> <td>X 0 X 0</td> </tr> <tr> <td>START</td> <td>X X X X</td> </tr> </tbody> </table>	POS.	CONTACT		1-2 3-4 5-6 7-8	STOP	0 0 0 0	0	X 0 X 0	START	X X X X	R
POS.	CONTACT																									
	1-2 3-4																									
STOP	0 0																									
0	X 0																									
START	X X																									
POS.	CONTACT																									
	1-2 3-4 5-6 7-8																									
STOP	0 0 0 0																									
0	X 0 X 0																									
START	X X X X																									
Switch with two fixed-positions, suitable for "automatic-manual" service			<table border="1"> <thead> <tr> <th>POS.</th> <th>CONTACT</th> </tr> <tr> <td></td> <td>1-2 3-4</td> </tr> </thead> <tbody> <tr> <td>0</td> <td>X 0</td> </tr> <tr> <td>1</td> <td>0 X</td> </tr> </tbody> </table>	POS.	CONTACT		1-2 3-4	0	X 0	1	0 X		<table border="1"> <thead> <tr> <th>POS.</th> <th>CONTACT</th> </tr> <tr> <td></td> <td>1-2 3-4 5-6 7-8</td> </tr> </thead> <tbody> <tr> <td>0</td> <td>X 0 X 0</td> </tr> <tr> <td>1</td> <td>0 X 0 X</td> </tr> </tbody> </table>	POS.	CONTACT		1-2 3-4 5-6 7-8	0	X 0 X 0	1	0 X 0 X	Z				
POS.	CONTACT																									
	1-2 3-4																									
0	X 0																									
1	0 X																									
POS.	CONTACT																									
	1-2 3-4 5-6 7-8																									
0	X 0 X 0																									
1	0 X 0 X																									
Switch			<table border="1"> <thead> <tr> <th>POS.</th> <th>CONTACT</th> </tr> <tr> <td></td> <td>1-2 3-4</td> </tr> </thead> <tbody> <tr> <td>0</td> <td>0 0</td> </tr> <tr> <td>1</td> <td>X X</td> </tr> </tbody> </table>	POS.	CONTACT		1-2 3-4	0	0 0	1	X X		<table border="1"> <thead> <tr> <th>POS.</th> <th>CONTACT</th> </tr> <tr> <td></td> <td>1-2 3-4 5-6</td> </tr> </thead> <tbody> <tr> <td>0</td> <td>0 0 0 0</td> </tr> <tr> <td>1</td> <td>X X X X</td> </tr> </tbody> </table>	POS.	CONTACT		1-2 3-4 5-6	0	0 0 0 0	1	X X X X	I				
POS.	CONTACT																									
	1-2 3-4																									
0	0 0																									
1	X X																									
POS.	CONTACT																									
	1-2 3-4 5-6																									
0	0 0 0 0																									
1	X X X X																									
Three fixed position switch can be padlocked in the centre position. Versions: single pole - double pole - triple pole			<table border="1"> <thead> <tr> <th>POS.</th> <th>CONTACT</th> </tr> <tr> <td></td> <td>1-2 3-4</td> </tr> </thead> <tbody> <tr> <td>1</td> <td>X 0</td> </tr> <tr> <td>0</td> <td>0 0</td> </tr> <tr> <td>2</td> <td>0 X</td> </tr> </tbody> </table>	POS.	CONTACT		1-2 3-4	1	X 0	0	0 0	2	0 X		<table border="1"> <thead> <tr> <th>POS.</th> <th>CONTACT</th> </tr> <tr> <td></td> <td>1-2 3-4 5-6 7-8</td> </tr> </thead> <tbody> <tr> <td>1</td> <td>X 0 X 0</td> </tr> <tr> <td>0</td> <td>0 0 0 0</td> </tr> <tr> <td>2</td> <td>0 X 0 X</td> </tr> </tbody> </table>	POS.	CONTACT		1-2 3-4 5-6 7-8	1	X 0 X 0	0	0 0 0 0	2	0 X 0 X	C
POS.	CONTACT																									
	1-2 3-4																									
1	X 0																									
0	0 0																									
2	0 X																									
POS.	CONTACT																									
	1-2 3-4 5-6 7-8																									
1	X 0 X 0																									
0	0 0 0 0																									
2	0 X 0 X																									
Three position switch can be padlocked in centre position with spring return to 0 from positions 1 and 2.			<table border="1"> <thead> <tr> <th>POS.</th> <th>CONTACT</th> </tr> <tr> <td></td> <td>1-2 3-4</td> </tr> </thead> <tbody> <tr> <td>1</td> <td>X 0</td> </tr> <tr> <td>0</td> <td>0 0</td> </tr> <tr> <td>2</td> <td>0 X</td> </tr> </tbody> </table>	POS.	CONTACT		1-2 3-4	1	X 0	0	0 0	2	0 X		<table border="1"> <thead> <tr> <th>POS.</th> <th>CONTACT</th> </tr> <tr> <td></td> <td>1-2 3-4 5-6 7-8</td> </tr> </thead> <tbody> <tr> <td>1</td> <td>X 0 X 0</td> </tr> <tr> <td>0</td> <td>0 0 0 0</td> </tr> <tr> <td>2</td> <td>0 X 0 X</td> </tr> </tbody> </table>	POS.	CONTACT		1-2 3-4 5-6 7-8	1	X 0 X 0	0	0 0 0 0	2	0 X 0 X	W
POS.	CONTACT																									
	1-2 3-4																									
1	X 0																									
0	0 0																									
2	0 X																									
POS.	CONTACT																									
	1-2 3-4 5-6 7-8																									
1	X 0 X 0																									
0	0 0 0 0																									
2	0 X 0 X																									
5 position reversing start switch. Lever with fixed C position and spring return to 0 from A and B			<table border="1"> <thead> <tr> <th>POS.</th> <th>CONTACT</th> </tr> <tr> <td></td> <td>1-2 5-6 8-7 3-4</td> </tr> </thead> <tbody> <tr> <td>A</td> <td>X X 0 0</td> </tr> <tr> <td>0</td> <td>0 X 0 0</td> </tr> <tr> <td>C</td> <td>0 0 0 0</td> </tr> <tr> <td>0</td> <td>0 0 X 0</td> </tr> <tr> <td>B</td> <td>0 0 0 X</td> </tr> </tbody> </table>	POS.	CONTACT		1-2 5-6 8-7 3-4	A	X X 0 0	0	0 X 0 0	C	0 0 0 0	0	0 0 X 0	B	0 0 0 X			Y						
POS.	CONTACT																									
	1-2 5-6 8-7 3-4																									
A	X X 0 0																									
0	0 X 0 0																									
C	0 0 0 0																									
0	0 0 X 0																									
B	0 0 0 X																									
"Start" motors control with lever spring return to position B			<table border="1"> <thead> <tr> <th>POS.</th> <th>CONTACT</th> </tr> <tr> <td></td> <td>1</td> </tr> </thead> <tbody> <tr> <td>A</td> <td>X 0</td> </tr> <tr> <td>B</td> <td>0 0</td> </tr> </tbody> </table>	POS.	CONTACT		1	A	X 0	B	0 0			M												
POS.	CONTACT																									
	1																									
A	X 0																									
B	0 0																									



CSC Series... Control and signalling station

CODE SELECTION TABLE

Illustration	Entry ØD	Description	Diagram	Weight Kg	Codes
	1" ISO 7/1	Single body: double pushbutton		0.85	CSC-D
	1" NPT				CSC-DN
	1" ISO 7/1	Single body: illuminated pushbutton		0.90	CSC-G
	1" NPT				CSC-GN
	1" ISO 7/1	Double body: double illuminated pushbutton		1.60	CSC-GG
	1" NPT				CSC-GGN
	1" ISO 7/1	Single body: single signal lamp		0.80	CSC-L
	1" NPT				CSC-LN
	1" ISO 7/1	Double body: double signal lamp		1.57	CSC-LL
	1" NPT				CSC-LLN
	1" ISO 7/1	Single body: single pushbutton (1NA+1NC)		0.74	CSC-P
	1" NPT				CSC-PN
	1" ISO 7/1	Single body: single pushbutton 2NO+2NC		0.88	CSC-2P
	1" NPT				CSC-2PN
	1" ISO 7/1	Double body: pushbutton + indicator light		1.63	CSC-PL
	1" NPT				CSC-PLN
	1" ISO 7/1	Double body: two pushbuttons		1.69	CSC-PP
	1" NPT				CSC-PPN
	1" ISO 7/1	Single body: single maintained pushbutton (maintained) (1NA+1NC)		0.90	CSC-B
	1" NPT				CSC-BN
	1" ISO 7/1	Single body: single maintained pushbutton (maintained) (2NA+2NC)		0.92	CSC-2B
	1" NPT				CSC-2BN







CSC Series... Control and signalling station

CODE SELECTION TABLE

Illustration	Entry ØD	Description	Diagram	Weight Kg	Codes
	1" ISO 7/1	Single body: mushroom head pushbutton (1NO+ 1NC)		0.92	CSC-F
	1" NPT				CSC-FN
	1" ISO 7/1	Single body: mushroom head pushbutton (2NO+ 2NC)		0.94	CSC-2F
	1" NPT				CSC-2FN
	1" ISO 7/1	Single body: 'twist to release' mushroom head pushbutton (1NO+ 1NC)		0.92	CSC-R
	1" NPT				CSC-RN
	1" ISO 7/1	Single body: 'twist to release' mushroom head pushbutton (2NA+2NC)		0.94	CSC-2R
	1" NPT				CSC-2RN
Selectors					
	1" ISO 7/1	Single body: single pole selector		0.87	CSC-1C
	1" NPT				CSC-1CN
	1" ISO 7/1	Single body: double pole selector		0.89	CSC-2C
	1" NPT				CSC-2CN
	1" ISO 7/1	Single body: triple pole selector		0.91	CSC-3C
	1" NPT				CSC-3CN
	1" ISO 7/1	Single body: single pole switch		0.87	CSC-1I
	1" NPT				CSC-1IN
	1" ISO 7/1	Single body: double pole switch		0.89	CSC-2I
	1" NPT				CSC-2IN
	1" ISO 7/1	Single body: triple pole switch		0.91	CSC-3I
	1" NPT				CSC-3IN
	1" ISO 7/1	Single body: run/stop selector		0.89	CSC-1R
	1" NPT				CSC-1RN
	1" ISO 7/1	Single body: single pole selector		0.89	CSC-1W
	1" NPT				CSC-1WN
	1" ISO 7/1	Single body: double pole selector		0.91	CSC-2W
	1" NPT				CSC-2WN
	1" ISO 7/1	Single body: run/stop selector		0.89	CSC-1X
	1" NPT				CSC-1XN
	1" ISO 7/1	Single body: reversing start switch		0.89	CSC-1Y
	1" NPT				CSC-1YN
	1" ISO 7/1	Single body: single pole circuit breaker		0.89	CSC-1Z
	1" NPT				CSC-1ZN
	1" ISO 7/1	Single body: double pole circuit breaker		0.89	CSC-2Z
	1" NPT				CSC-2ZN
	1" ISO 7/1	Single body: triple pole circuit breaker		0.89	CSC-3Z
	1" NPT				CSC-3ZN









CSC Series... Control and signalling station

CODE SELECTION TABLE

Illustration	Combinations		Weight Kg	Codes
	Entry ØD	Description		
	1" ISO 7/1	Double body: single pole changeover switch + indicator light	1.65	CSC-1CL
	1" NPT			CSC-1CLN
	1" ISO 7/1	Double body: double pole changeover switch + indicator light	1.67	CSC-2CL
	1" NPT			CSC-2CLN
	1" ISO 7/1	Double body: triple pole changeover switch + indicator light	1.69	CSC-3CL
	1" NPT			CSC-3CLN
	1" ISO 7/1	Double body: pushbutton + single pole selector	1.70	CSC-P1C
	1" NPT			CSC-P1CN
	1" ISO 7/1	Double body: pushbutton + double pole selector	1.72	CSC-P2C
	1" NPT			CSC-P2CN
	1" ISO 7/1	Double body: pushbutton + triple pole selector	1.74	CSC-P3C
	1" NPT			CSC-P3CN
	1" ISO 7/1	Double body: single pole circuit breaker + indicator light	1.65	CSC-1ZL
	1" NPT			CSC-1ZLN
	1" ISO 7/1	Double body: double pole circuit breaker + indicator light	1.67	CSC-2ZL
	1" NPT			CSC-2ZLN
	1" ISO 7/1	Double body: triple pole circuit breaker + indicator light	1.65	CSC-3ZL
	1" NPT			CSC-3ZLN
	1" ISO 7/1	Double body: pushbutton + single pole circuit breaker	1.70	CSC-P1Z
	1" NPT			CSC-P1ZN
	1" ISO 7/1	Double body: pushbutton + double pole circuit breaker	1.72	CSC-P2Z
	1" NPT			CSC-P2ZN
	1" ISO 7/1	Double body: pushbutton + triple pole circuit breaker	1.74	CSC-P3Z
	1" NPT			CSC-P3ZN
	1" ISO 7/1	Double body: run/stop selector + single pole switch	1.74	CSC-1R1C
	1" NPT			CSC-1R1CN
	1" ISO 7/1	Double body: run/stop selector + single pole switch	1.76	CSC-1R2C
	1" NPT			CSC-1R2CN
	1" ISO 7/1	Double body: run/stop selector + single pole switch	1.78	CSC-1R3C
	1" NPT			CSC-1R3CN
	1" ISO 7/1	Double body: run/stop selector + single pole circuit breaker	1.73	CSC-1R1Z
	1" NPT			CSC-1R1ZN
	1" ISO 7/1	Double body: run/stop selector + double pole circuit breaker	1.76	CSC-1R2Z
	1" NPT			CSC-1R2ZN
	1" ISO 7/1	Double body: run/stop selector + triple pole circuit breaker	1.78	CSC-1R3Z
	1" NPT			CSC-1R3ZN

CSC Series... Control and signalling station

CODE SELECTION TABLE

Illustration	Entry ØD	Description	Weight Kg	Codes
	1" ISO 7/1	Double body: run/stop selector + single pole switch	1.73	CSC-1X1C
	1" NPT			CSC-1X1CN
	1" ISO 7/1	Double body: run/stop selector + double pole changeover switch	1.75	CSC-1X2C
	1" NPT			CSC-1X2CN
	1" ISO 7/1	Double body: run/stop selector + triple pole changeover switch	1.73	CSC-1X3C
1" NPT	CSC-1X3CN			
	1" ISO 7/1	Double body: run/stop selector + single pole circuit breaker	1.73	CSC-1X1Z
	1" NPT			CSC-1X1ZN
	1" ISO 7/1	Double body: run/stop selector + double pole circuit breaker	1.75	CSC-1X2Z
	1" NPT			CSC-1X2ZN
	1" ISO 7/1	Double body: run/stop selector + triple pole circuit breaker	1.77	CSC-1X3Z
1" NPT	CSC-1X3ZN			
	1" ISO 7/1	Double body: run/stop selector + indicator light	1.67	CSC-1RL
	1" NPT			CSC-1RLN
	1" ISO 7/1	Double body: run/stop selector + indicator light	1.66	CSC-1XL
	1" NPT			CSC-1XLN
	1" ISO 7/1	Single body: instrument casing	0.75	CSC-H
	1" NPT			CSC-HN
	1" ISO 7/1	Double body: instrument casing	1.50	CSC-HH
	1" NPT			CSC-HHN
	1" ISO 7/1	Double body: run/stop selector + instrument casing	1.67	CSC-1RH
	1" NPT			CSC-1RHN
	1" ISO 7/1			CSC-1XH
	1" NPT			CSC-1XHN
	1" ISO 7/1	Single body: Key operated handle with quick coupling for cam switch. Stainless steel bushing.	0.95	CSC-1ZK
	1" NPT			CSC-1ZKN
	1" ISO 7/1			CSC-2ZK
	1" NPT			CSC-2ZKN
	1" ISO 7/1	Single body: break glass emergency pushbutton with hammer	1.10	CSCPEA2
	1" NPT			CSCPEA2N

Note:
For non-standard arrangements, contact the Sales Office.

EFDC Series... Control and signalling station



CROSS-SECTION VIEW



DESCRIPTION

EFDC series control and monitoring units are suitable for the control and signalling of devices, both on board the machine or remotely, and are used in the chemical, petrochemical and pharmaceutical industries, and any location which requires an explosion proof system. A feature of this station is the ability to mount up to four operators on the cover.

MECHANICAL FEATURES OF ENCLOSURES

Body and lid:	Low copper content aluminium alloy, complete with wall fastening lugs.
Gaskets:	Acid, hydrocarbon and high temperature resistant silicon positioned between the body and the cover
Certification label:	Adhesive affixed to external surface
Screws:	Stainless steel
Earth screw:	Internal M5 on body and lid connected by a 2.5 mm ² wire
Coating:	Polyester RAL 7035 (Light grey)
Threaded entries:	One upper and one lower Ø 1"

Resistenza alla corrosione:

The STANDARD of the aluminium alloy used by Cortem has passed the tests required by standards EN60068-2-30 (hot-humid cycles) and EN60068-2-11 (salt fog test)

MECHANICAL FEATURES OF CONTROL AND SIGNALLING DEVICES

Pushbutton:	Coloured nylon
Illuminated pushbutton:	Clear coloured polycarbonate
Control lever:	Aluminium alloy
Badge:	Anodised aluminium, white lettering on black background
Outer body:	Aluminium alloy
Internal bushing and pin:	Stainless steel
Gaskets:	Acid and hydrocarbon resistant NBR
Station assembly:	Screwed onto cover
Contacts assembly:	Snap action on an appropriate flange to ensure the quick connection of entire contacts block to the station
External body lens:	Impact and UV resistant polycarbonate lens, coloured or transparent

ELECTRICAL FEATURES

Contacts for pushbuttons:	Max. 10A 600 V
Switches:	16A, 690 V
Indicator lights:	24/250V, 3W

ACCESSORIES UPON REQUEST / SPECIAL REQUESTS

RAL 2004 (Pure orange) internal anti-condensation coating

External polyester coatings in various colours (specify RAL colour)

Cablegland / fittings

System protecting against accidental operation for mushroom-head push-buttons serie EFDC-21EMR and EFDC-21EMC (code **M-990**)

EFDC Series... Control and signalling station

DIMENSIONAL DRAWING

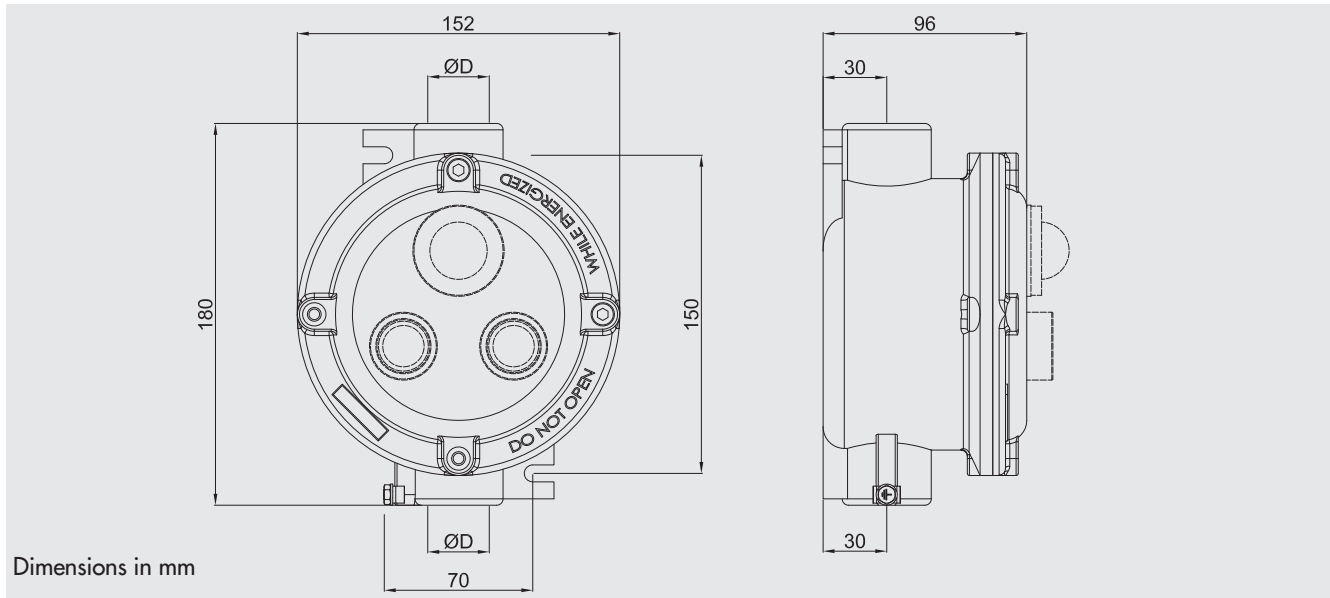















CODE SELECTION TABLE

Illustration	Entry ØD	Description	Diagram	Weight Kg	Codes
	1" ISO 7/1	Single body: button		1.4	EFDC-21
	1" NPT				EFDC-21N
	1" ISO 7/1	Single body: indicator light		1.4	EFDC-25
	1" NPT				EFDC-25N
	1" ISO 7/1	Single body: two buttons		1.5	EFDC-22
	1" NPT				EFDC-22N
	1" ISO 7/1	Single body: two indicator lights		1.5	EFDC-24
	1" NPT				EFDC-24N
	1" ISO 7/1	Single body: pushbutton with indicator light		1.5	EFDC-23
	1" NPT				EFDC-23N
	1" ISO 7/1	Single body: three buttons		1.6	EFDC-27
	1" NPT				EFDC-27N
	1" ISO 7/1	Single body: three indicator lights		1.6	EFDC-20
	1" NPT				EFDC-20N
	1" ISO 7/1	Single body: two pushbuttons and an indicator light		1.6	EFDC-28
	1" NPT				EFDC-28N
	1" ISO 7/1	Single body: pushbutton with two indicator lights		1.6	EFDC-29
	1" NPT				EFDC-29N











EFDC Series... Control and signalling station

CODE SELECTION TABLE

Illustration	Entry ØD	Description	Diagram	Weight Kg	Codes	
	1" ISO 7/1	Single body: four pushbuttons		1.8	EFDC-30	
	1" NPT				EFDC-30N	
	1" ISO 7/1	Single body: four indicator lights		1.8	EFDC-31	
	1" NPT				EFDC-31N	
	1" ISO 7/1	Single body: three pushbuttons with an indicator light		1.8	EFDC-32	
	1" NPT				EFDC-32N	
	1" ISO 7/1	Single body: two pushbuttons with two indicator lights		1.8	EFDC-33	
	1" NPT				EFDC-33N	
	1" ISO 7/1	Single body: pushbutton with three indicator lights		1.8	EFDC-34	
	1" NPT				EFDC-34N	
		1" ISO 7/1	Single body: emergency pushbutton station with protective glass and hammer		1.4	EFDC-21EMV
		1" NPT				EFDC-21EMVN
	1" ISO 7/1	Single body: emergency pushbutton station		1.4	EFDC-21EM	
	1" NPT				EFDC-21EMN	
	1" ISO 7/1	Emergency pushbutton station with 'twist to release' mushroom head pushbutton		1.4	EFDC-21EMR	
	1" NPT				EFDC-21EMRN	
	1" ISO 7/1	Emergency pushbutton station with key release mushroom head pushbutton (when the button is pressed, turn the key to release)		1.4	EFDC-21EMC	
	1" NPT				EFDC-21EMCN	

EFDC Series... Control and signalling station

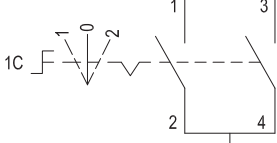
CODE SELECTION TABLE

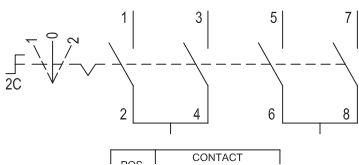
Illustration	Entry ØD	Description	Diagram	Weight Kg	Codes
	1" ISO 7/1	Emergency pushbutton station with 'twist to release' mushroom head pushbutton and pushbutton		1.5	EFDC-21EMRV1
	1" NPT				EFDC-21EMRV1N
	1" ISO 7/1	Emergency pushbutton station with 'twist to release' mushroom head pushbutton, pushbutton and indicator light		1.5	EFDC-21EMRV2
	1" NPT				EFDC-21EMRV2N
	1" ISO 7/1	Single body: emergency pushbutton station with mushroom head pushbutton and key reset		1.4	EFDC-21EMCV1
	1" NPT				EFDC-21EMCV1N
	1" ISO 7/1	Single body: emergency pushbutton station with mushroom head pushbutton and key reset, pushbutton and indicator light		1.4	EFDC-21EMCV2
	1" NPT				EFDC-21EMCV2N
	1" ISO 7/1	Single body: Single pole selector		2.0	EFDC-1C
	1" NPT				EFDC-1CN
	1" ISO 7/1	Single body: Double pole selector		2.1	EFDC-2C
	1" NPT				EFDC-2CN

Note:
For non-standard arrangements, contact the Sales Office.

EFDC Series... Control and signalling station (Double body)

DESCRIPTION

EFDC series control and signalling stations -.../... are double bodied enclosures and can contain up to eight devices. They are used for the remote control of devices such as distribution panels for lights, pumps, starter motors, etc.

DIMENSIONAL DRAWING

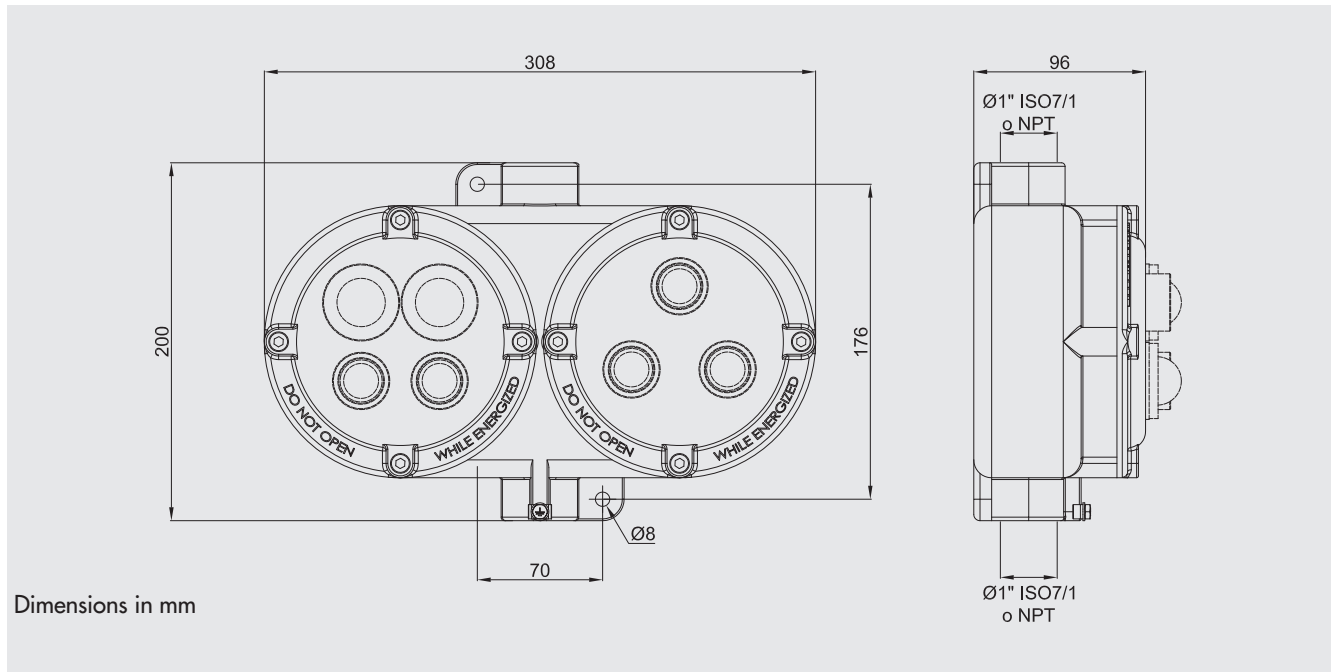

CODE SELECTION TABLE

Use the code in the selection table of EFDC single body stations to compose the code for double body stations.

Example:

EFDC-20/22

Double body station with three indicator lights in the left-hand enclosure and two pushbuttons in the one to the right. Two 1" ISO7/1 fittings.

EFDC-23/21N

Double body station with pushbutton and indicator light in the left-hand enclosure and a pushbutton in the one to the right. Two 1" NPT fittings.

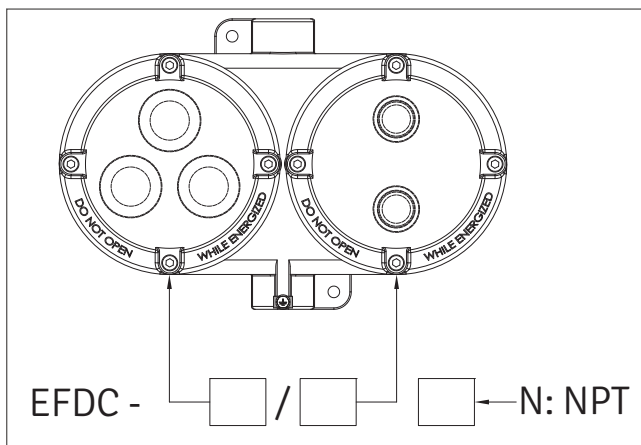

EFDC33/2C connected to an instrument casing CSC-H with ammeter.



CSC Series... Switches, selectors and circuit breaker



EXPLODED VIEW



DESCRIPTION

The switches, circuit breakers and selectors which make up the CSC series are 16 A rotary type with a front control handle. Supplied with 1" Male to 3/4" Female reducer

MECHANICAL FEATURES

Body and lid:	Low copper content aluminium alloy, complete with wall fastening lugs.
Gaskets:	Acid, hydrocarbon and high temperature resistant silicon positioned between the body and the cover
Control lever:	Coated aluminium alloy
Certification label:	Adhesive affixed to external surface
Badge:	Anodised aluminium, white lettering on black background
Internal bushing and pin:	Stainless steel
Control lever:	Aluminium alloy
Screws:	Stainless steel
Earth screw:	Internal M5 on body and lid connected by a 2.5 mm ² wire
Coating:	Polyester RAL 7035 (Light grey)
Threaded entries:	One upper and one lower Ø 1" complete with Male 1" - Female 3/4" adapter

Resistenza alla corrosione:

The STANDARD of the aluminium alloy used by Cortem has passed the tests required by standards EN60068-2-30 (hot-humid cycles) and EN60068-2-11 (salt fog test)

ELECTRICAL FEATURES

Switches: 16A, 690 V

ACCESSORIES UPON REQUEST / SPECIAL REQUESTS

RAL 2004 (Pure orange) internal anti-condensation coating

External polyester coatings in various colours (specify RAL colour)

Stainless steel or cast iron version available with minimum production batches. Contact your sales representative for more details. (sample code stainless steel CSC-216IN, cast iron sample code CSC-216GJ)

Cablegland / fittings

CSC Series... Switches, selectors and circuit breaker

DIMENSIONAL DRAWING

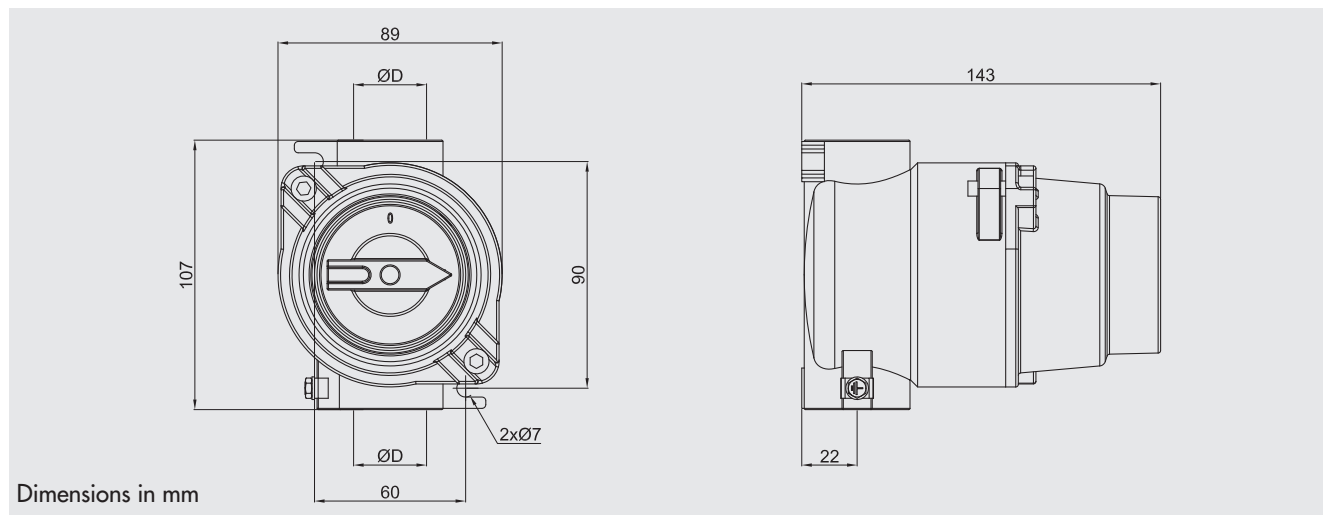

SELECTION TABLE

Illustration	Entry ØD (*)	Description	Badge	Arrangement	Capacity	Poles	Weight Kg	Code
	1" ISO 7/1	Switch with 2 fixed positions '0-1'			16 A	2	0.95	CSC-216
	1" NPT							CSC-216N
	1" ISO 7/1	Switch with 2 fixed positions '0-1'			16 A	3	0.86	CSC-316
	1" NPT							CSC-316N
	1" ISO 7/1	Switch with 2 fixed positions '0-1'			16 A	4	0.85	CSC-416
	1" NPT							CSC-416N
	1" ISO 7/1	Switch with 3 fixed positions '1-0-2'			16 A	2	0.89	CSCC-216
	1" NPT							CSCC-216N
	1" ISO 7/1	Switch with 3 fixed positions '1-2'			16 A	2	0.89	CSCD-216
	1" NPT							CSCD-216N
	1" ISO 7/1	Inverter with 3 fixed positions '1-0-2'			16 A	2	0.89	CSCI-216
	1" NPT							CSCI-216N

* Supplied with 1" Male to 3/4" Female reducer

EFSCO Series... Switches, selectors and circuit breaker

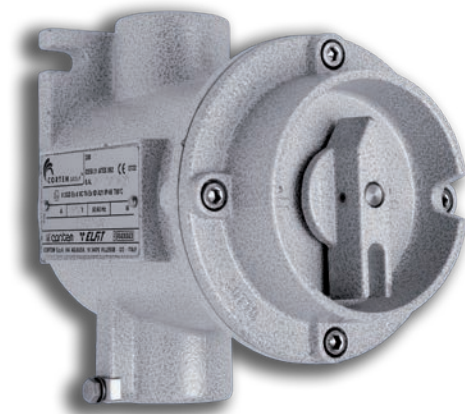

EXPLODED VIEW



The switches, circuit breakers and selectors which make up the EFSCO series are 25, 32, 40 and 63 A rotary type with a front control handle.

MECHANICAL FEATURES

Body and lid:	Low copper content aluminium alloy, complete with wall fastening lugs.
Gaskets:	Acid, hydrocarbon and high temperature resistant silicon positioned between the body and the cover
Control lever:	Coated aluminium alloy
Certification label:	Adhesive affixed to external surface
Badge:	Anodised aluminium, white lettering on black background
Internal bushing and pin:	Stainless steel
Screws:	Stainless steel
Earth screw:	Internal M5 on body and lid connected by a 2.5 mm ² wire
Coating:	Polyester RAL 7035 (Light grey)
Resistenza alla corrosione:	The STANDARD of the aluminium alloy used by Cortem has passed the tests required by standards EN60068-2-30 (hot-humid cycles) and EN60068-2-11 (salt fog test)

ELECTRICAL FEATURES

Switches: 25 A to 63 A, 690 V

ACCESSORIES UPON REQUEST / SPECIAL REQUESTS

RAL 2004 (Pure orange) internal anti-condensation coating

External polyester coatings in various colours (specify RAL colour)

Stainless steel version available with minimum production batches. Contact your sales representative for more details. (sample code stainless steel EFSCO-266IN)

Cableland / fittings

EFSCO Series... Switches, selectors and circuit breaker

DIMENSIONAL DRAWING

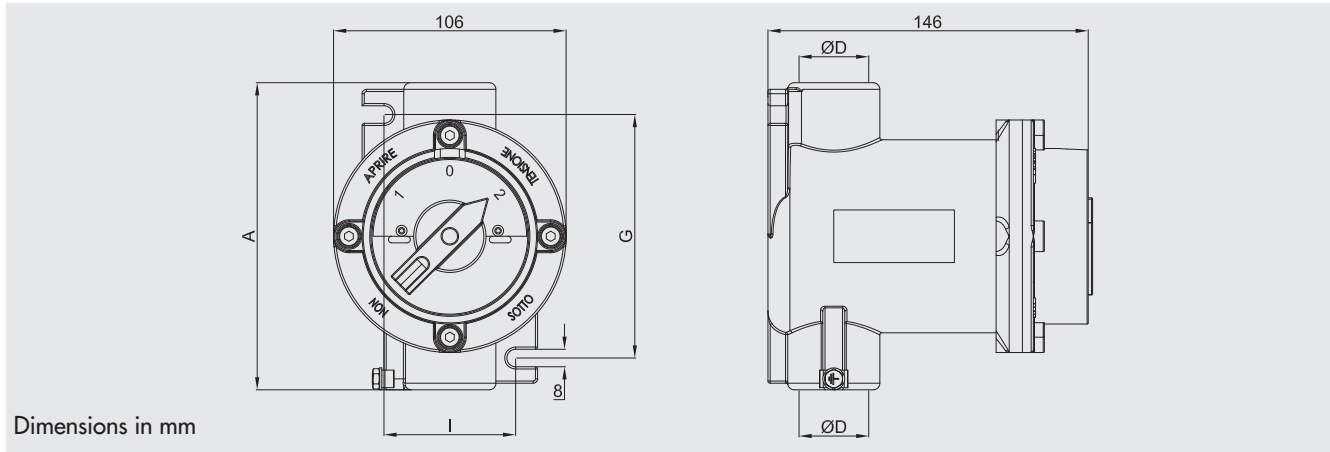

Dimensions in mm

CODE SELECTION TABLE

Illustration	Entry D ISO7/1	A	G	I	Description	Arrangement	Capacity	Poles	Weight Kg	Code																			
	1"	140	110	60	Switch with 2 fixed positions '0-1'	 <table border="1"> <tr><th>POS.</th><th colspan="3">CONTACT</th></tr> <tr><td>0</td><td>O</td><td>O</td></tr> <tr><td>1</td><td>X</td><td>X</td></tr> </table>	POS.	CONTACT			0	O	O	1	X	X	25 A	2	1.14	EFSCO-22									
	POS.	CONTACT																											
	0	O	O																										
	1	X	X																										
	1"	140	110	60			32 A	2	1.20	EFSCO-32																			
	1"	140	110	60			40 A	2	1.35	EFSCO-42																			
	1 1/2"	160	120	80	63 A	2	1.35	EFSCO-62																					
	1"	140	110	60	Switch with 2 fixed positions '0-1'	 <table border="1"> <tr><th>POS.</th><th colspan="3">CONTACT</th></tr> <tr><td>0</td><td>O</td><td>O</td><td>O</td></tr> <tr><td>1</td><td>X</td><td>X</td><td>X</td></tr> </table>	POS.	CONTACT			0	O	O	O	1	X	X	X	25 A	3	1.14	EFSCO-23							
	POS.	CONTACT																											
	0	O	O	O																									
	1	X	X	X																									
	1"	140	110	60	32 A	3	1.20	EFSCO-33																					
1"	140	110	60	40 A	3	1.35	EFSCO-43																						
1 1/2"	160	120	80	63 A	3	1.40	EFSCO-63																						
1"	140	110	60	Switch with 2 fixed positions '0-1'	 <table border="1"> <tr><th>POS.</th><th colspan="4">CONTACT</th></tr> <tr><td>0</td><td>O</td><td>O</td><td>O</td><td>O</td></tr> <tr><td>1</td><td>X</td><td>X</td><td>X</td><td>X</td></tr> </table>	POS.	CONTACT				0	O	O	O	O	1	X	X	X	X	25 A	4	1.18	EFSCO-24					
POS.	CONTACT																												
0	O	O	O			O																							
1	X	X	X			X																							
1"	140	110	60	32 A	4	1.20	EFSCO-34																						
1"	140	110	60	40 A	4	1.35	EFSCO-44																						
1 1/2"	160	120	80	63 A	4	1.40	EFSCO-64																						
	1"	140	110	60	Circuit breaker with 2 fixed positions '1-2'	 <table border="1"> <tr><th>POS.</th><th colspan="2">CONTACT</th></tr> <tr><td>1</td><td>X</td><td>O</td></tr> <tr><td>2</td><td>O</td><td>X</td></tr> </table>	POS.	CONTACT		1	X	O	2	O	X	25 A	1	1.20	EFSCO-26										
	POS.	CONTACT																											
	1	X	O																										
	2	O	X																										
	1"	140	110	60			32 A	1	1.18	EFSCO-36																			
	1"	140	110	60			40 A	1	1.20	EFSCO-46																			
1"	140	110	60	63 A	1	1.40	EFSCO-66																						
1"	140	110	60	Circuit breaker with 2 fixed positions '1-2'	 <table border="1"> <tr><th>POS.</th><th colspan="4">CONTACT</th></tr> <tr><td>0</td><td>X</td><td>O</td><td>X</td><td>O</td></tr> <tr><td>1</td><td>O</td><td>X</td><td>O</td><td>X</td></tr> </table>	POS.	CONTACT				0	X	O	X	O	1	O	X	O	X	25 A	2	1.18	EFSCO-266					
POS.	CONTACT																												
0	X	O	X	O																									
1	O	X	O	X																									
1"	140	110	60	32 A	2	1.18	EFSCO-366																						
1 1/2"	160	120	80	40 A	2	1.20	EFSCO-466																						
	1"	140	110	60	Switch with 3 fixed positions '1-0-2'	 <table border="1"> <tr><th>POS.</th><th colspan="2">CONTACT</th></tr> <tr><td>1</td><td>X</td><td>O</td></tr> <tr><td>2</td><td>O</td><td>X</td></tr> </table>	POS.	CONTACT		1	X	O	2	O	X	25 A	1	1.14	EFSCO-242										
	POS.	CONTACT																											
	1	X	O																										
	2	O	X																										
	1"	140	110	60			32 A	1	1.18	EFSCO-342																			
	1"	140	110	60			40 A	1	1.18	EFSCO-442																			
	1"	140	110	60			63 A	1	1.40	EFSCO-642																			
	1"	140	110	60			Switch with 3 fixed positions '1-0-2'	 <table border="1"> <tr><th>POS.</th><th colspan="4">CONTACT</th></tr> <tr><td>1</td><td>X</td><td>O</td><td>X</td><td>O</td></tr> <tr><td>0</td><td>O</td><td>O</td><td>O</td><td>O</td></tr> <tr><td>2</td><td>O</td><td>X</td><td>O</td><td>X</td></tr> </table>	POS.	CONTACT				1	X	O	X	O	0	O	O	O	O	2	O	X	O	X	25 A
POS.	CONTACT																												
1	X	O	X	O																									
0	O	O	O	O																									
2	O	X	O	X																									
1"	140	110	60	32 A	2	1.18	EFSCO-344																						
1 1/2"	160	120	80	40 A	2	1.18	EFSCO-444																						

EMHA-9 and CSC-H Series... Instrument housings

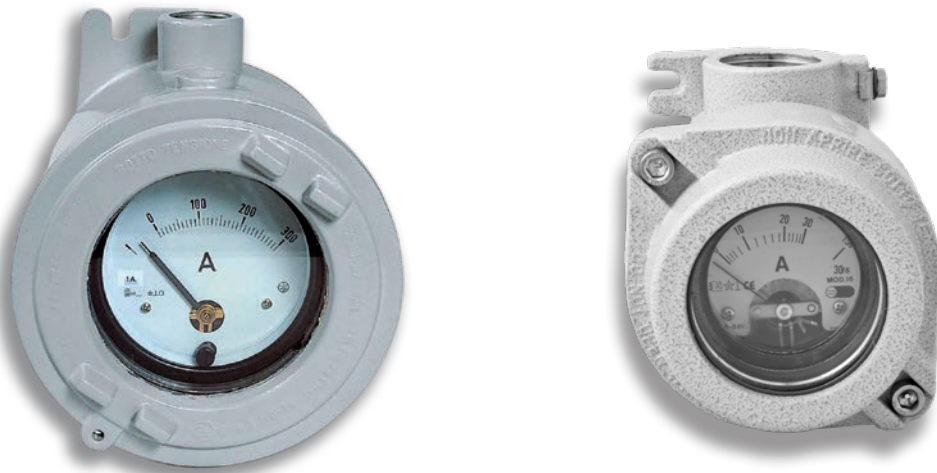

CROSS-SECTION VIEW



DESCRIPTION

EMHA-9 instrument housings are normally used to contain medium-sized analogue instruments such as ammeters and voltmeters. CSC-H instrument housings are normally used to contain small-sized analogue instruments such as ammeters and voltmeters.

MECHANICAL FEATURES

Body and lid:	Low copper content aluminium alloy, complete with wall fastening lugs.
Gaskets:	Acid, hydrocarbon and high temperature resistant silicon positioned between the body and the cover tempered and temperature resistant
Glass	Aluminium
Internal frame:	Aluminium
Certification label:	Adhesive affixed to external surface
Screws:	Stainless steel
Earth screw:	Internal M5 on body and lid connected by a 2.5 mm ² wire
Coating:	Polyester RAL 7035 (Light grey)
Threaded entries:	One upper and one lower Ø 3/4"

Resistenza alla corrosione: The STANDARD of the aluminium alloy used by Cortem has passed the tests required by standards EN60068-2-30 (hot-humid cycles) and EN60068-2-11 (salt fog test)

ACCESSORIES UPON REQUEST / SPECIAL REQUESTS

Measuring instruments (Voltmeter - Ammeter)

RAL 2004 (Pure orange) internal anti-condensation coating

External polyester coatings in various colours (specify RAL colour)

Stainless steel or cast iron version available with minimum production batches. Contact your sales representative for more details. (sample code stainless steel EMHA-9IN, cast iron sample code EMHA-9GJ)

Cablegland / fittings

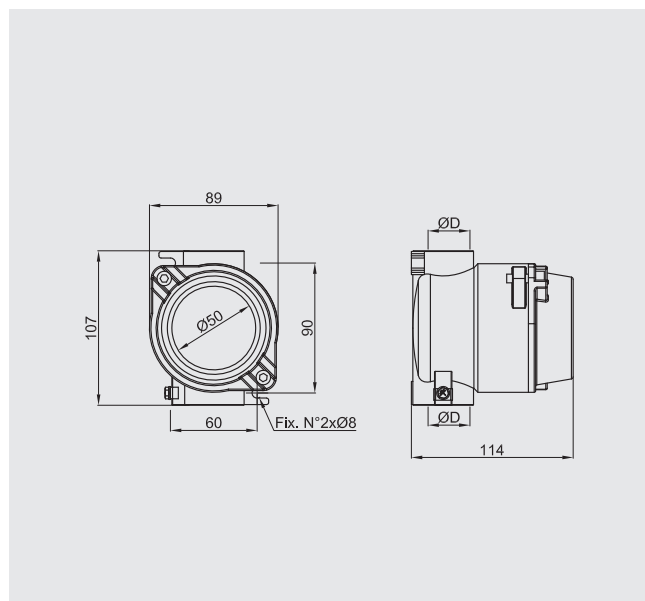
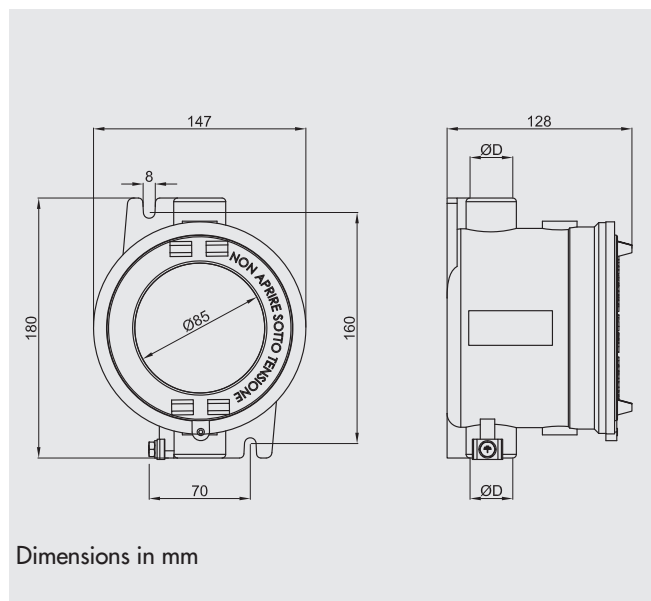

EMHA-9 and CSC-H Series... Instrument housings

DIMENSIONAL DRAWING



Dimensions in mm

CODE SELECTION TABLE

Illustration	Entry $\varnothing D$	Description	Weight Kg	Codes
	3/4" ISO7/1	Instrument casing $\varnothing 85$ mm	1.88	EMHA-9
	3/4" NPT			EMHA-9N
	1" ISO 7/1	Single body; instrument casing	0.75	CSC-H
	1" NPT			CSC-HN